

# WARTON



PROFESSIONAL GOBO LIGHTING



Zhongshan WartonLighting Technology Co, Ltd.  
3th Floor, No.2, 1st Road of Caosan Industry  
Guzhen, Zhongshan, Guangdong, China.  
Tel: +86 760 2238 9305  
Mobile: +86 134 1160 5325  
Web: [www.wartonlogo.com](http://www.wartonlogo.com)  
Email: [clark@artonlogo.com](mailto:clark@artonlogo.com)





# ABOUT US



Founded in 2012 by experts, Warton Industry Limited is a premier manufacturer of the projection equipment and gobos in Zhongshan city, Guangdong, China. We are focus on gobo projectors manufacturing from very R&D (include structure designs, electrical design, product tests, product optimizations ...etc.) until after-sales service. Our gobo projectors are all equipped with LED light source with different lumen output to suit different applications. Warton Ltd. keeps carry various projectors in both indoor and outdoor applications for worldwide users. On the other hand, Warton Ltd. specializes in gobos for corporate identities, branding, product launches, tradeshow exhibits, sports teams and anything you want to project. We manufacture custom gobos in one/two/three/four and full coloursto achieve all the projection purpose.

<b>R &amp; D Dept</b> Keep gathering experience, keeping product innovation and updating, keep focusing on user experience improvement.	<b>Production Dept</b> Detailed management including: schedule, assembling, inspections and packing etc. 100% qualification rate for every lamp.	<b>Gobo Technology Dept</b> Equipped with high-resolution laser carving machines and clean machines, operated by experienced craftsman. To ensure each gobo shows loveable image.
<b>Sales Dept</b> Clearly know customer's requirement with sensitive. Prompt and correct following customer's order with carefulness. Satisfy customers with experience. Support customer with thankfulness.	<b>Graphic Design Dept</b> Following custom gobo idea to design, edit, updating and optical applications geometrical calculate.	<b>Purchase Dept</b> After years of selections, purchase dept. build multiple and long-term supplier for our materials and packaging with high quality insurance and good cost control.
<b>CNC Dept</b> In the charge of IQC, Digital shaped and Sample making for R&D dept., to make sure high capacity and creativity.	<b>Purchase Dept</b> After years of selections, purchase dept. build multiple and long-term supplier for our materials and packaging with high quality insurance and good cost control.	



Sign quality guarantee with customer



Letter of Patent



Long-term Legal Counselor Service.



Finished product & QC



Assembly line

Specification

# 15W Image Static Type



Model NO.	WT-sr1520/WT-sr1565
Colors	Black (customizable)
LED chips	1x15W by CREE
Beam Angle	Beam Angle 15° or 25°
Input Voltage	AC 85-265V
Projection Distance	10M ( Dark Areas )
Waterproof	IP20/IP65
Gobo Spec	(Size) φ37mm(Viewable) φ23mm
Lamp Size	182x113x95mm
Net Weight	880g



Description

Equipped a single high-power CREE LED chip. According lwatt optimized drive solution, under hundreds of testing, realize luminous efficacy above 90%. Heat sink's 80% is made from model 1070 Aluminum, heat dissipation up to 95%. Beam angle are 15° and 25° for your selection.

Image Size Against Projection Distance

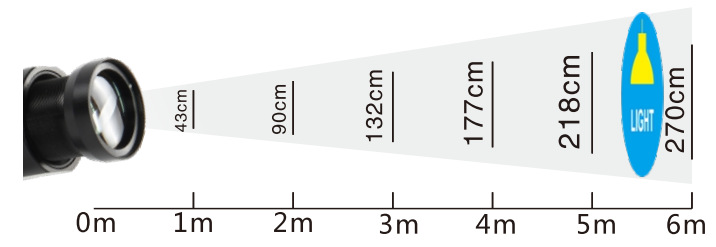
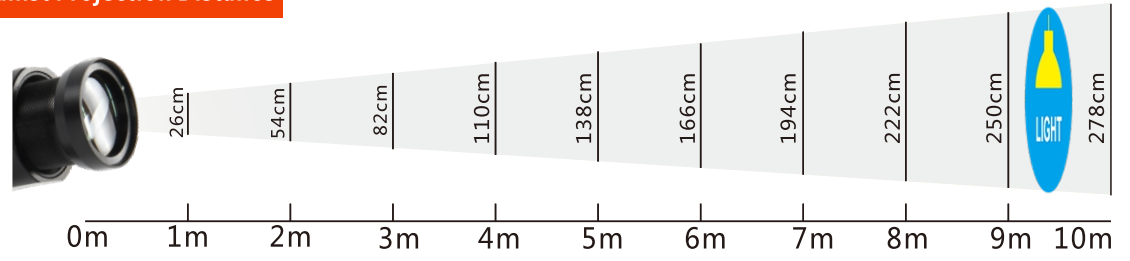

(\*Bigger image type)

Lamp Details

Aluminum Alloy shell

High Resolution Optical Lens

Drive

Long Life Cree Led

Standard Plug

EU AU UK US

Cases



**Specification**



**15W Image Rotatable Type**

Model NO.	WT-st1520/WT-st1565
Colors	Black (customizable)
LED chips	1x15W by CREE
Beam Angle	Beam Angle 15°
Input Voltage	110 or 220V(±20V)
Projection Distance	10M ( Dark Areas )
Waterproof	IP20/IP65
Gobo Spec	(Size) φ37mm(Viewable) φ23mm
Lamp Size	220X150X90mm
Net Weight	1170g



**Description**

Equipped a single high-power Cree LED chip. According to watt optimized drive solution, under hundreds of testing, realize luminous efficacy above 90%. Heat sink's 80% is made from model 1070 Aluminum, heat dissipation up to 95%. Turn On/Off and Rotating/Stop functions are controllable by switch key or remote. Beam angle is 15°

**Image Size Against Projection Distance**

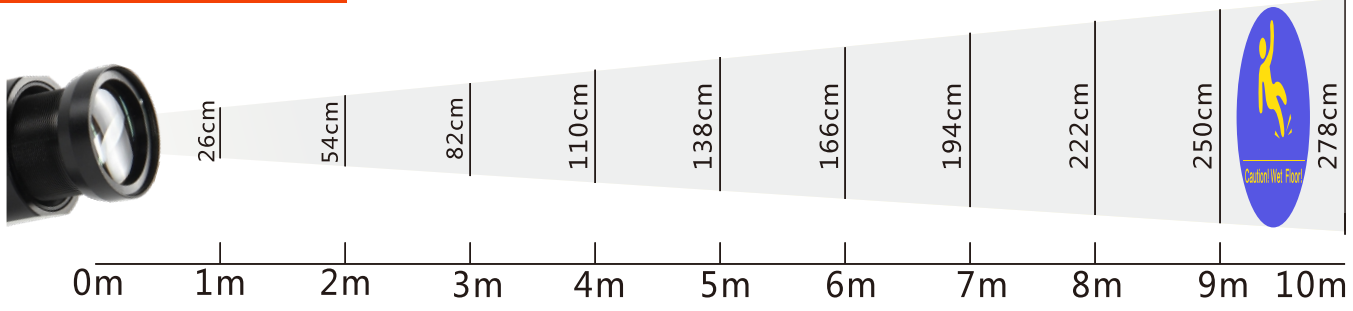

- Small decline
- IP20 or IP65
- Long life-span
- HD image

**Lamp Details**

Aluminum Alloy shell

High Resolution Optical Lens

Drive

Long Life Cree Led

Standard Plug

**Cases**

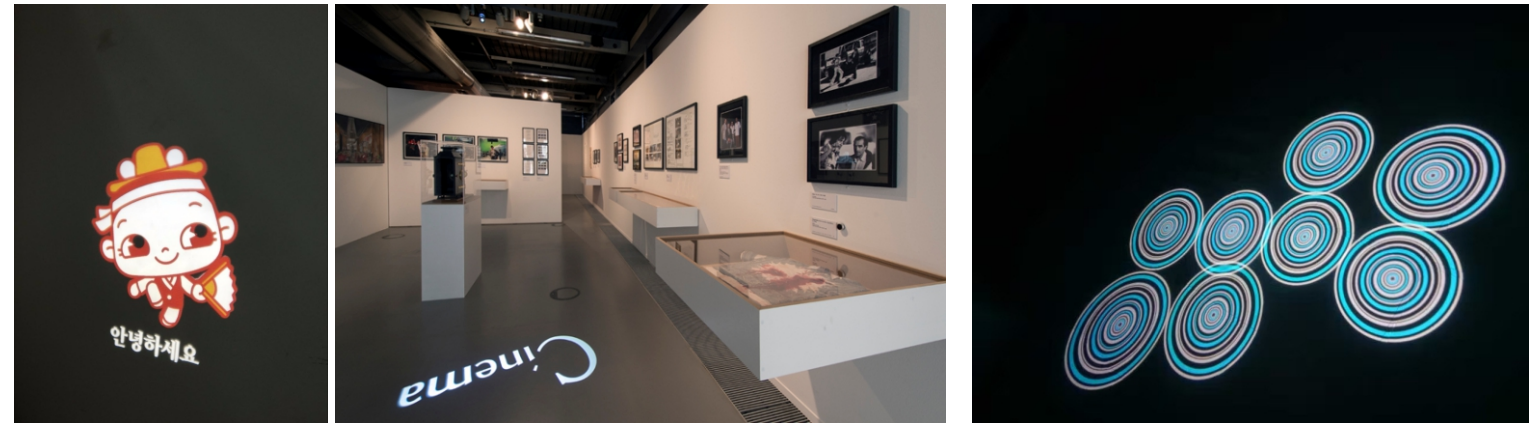

**Specification**



**30W Image Static Type**

Model NO.	WT-st3020/WT-st3065
Colors	Black (customizable)
LED chips	1x30W by OSRAM
Beam Angle	Beam Angle 15°
Input Voltage	AC 85-265V
Projection Distance	MAX 30M ( Dark Areas )
Waterproof	IP20/IP65
Gobo Spec	(Size) $\phi$ 37mm(Viewable) $\phi$ 23mm
Lamp Size	200X100X165mm
Net Weight	1200g



**Description**

Equipped a single high-power OSRAM LED chip. According to watt optimized drive solution, under hundreds of testing, realize luminous efficacy above 90%. Heat sink's 80% is made from model 1070 Aluminum, heat dissipation up to 95%. Beam angle is 15°

**Image Size Against Projection Distance**

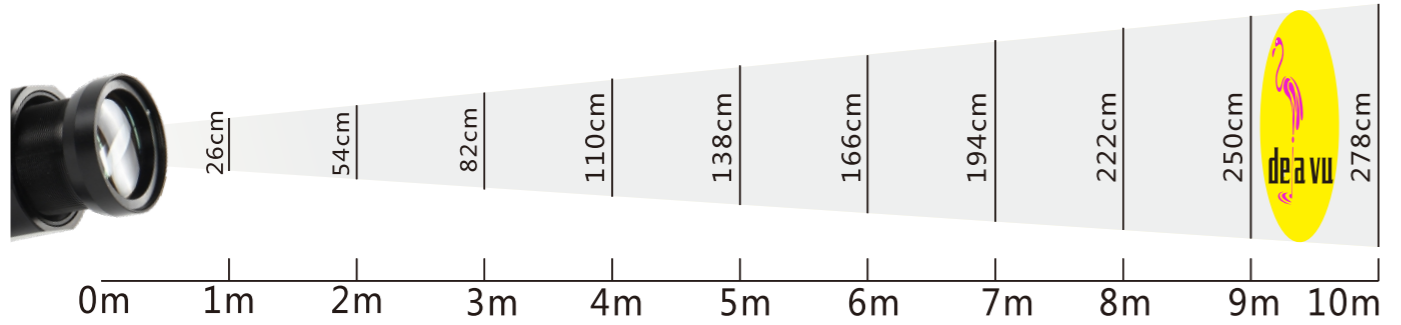

- Small decline
- IP20 or IP65
- Long life-span
- HD image

**Lamp Details**

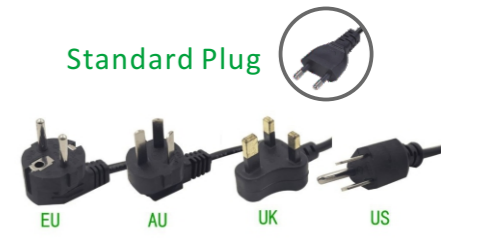
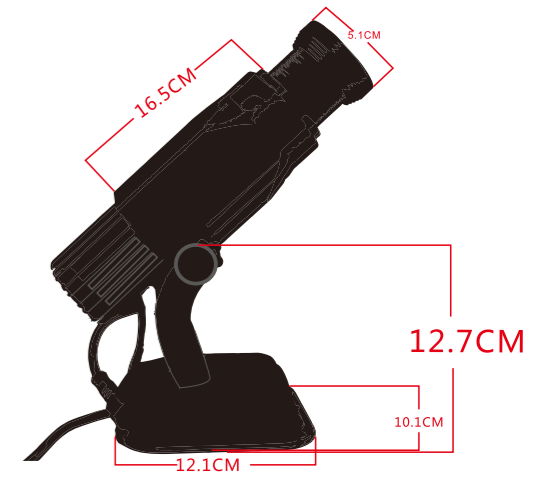

**Cases**



**Specification**



**30W Image Rotatable Type**

Model NO.	WT-rt3020/WT-rt3065
Colors	Black (customizable)
LED chips	1x30W by OSRAM
Beam Angle	Beam Angle 15°
Input Voltage	AC110V or 220V(±20V)
Projection Distance	MAX 30M ( Dark Areas )
Waterproof	IP20/IP65
Gobo Spec	(Size) φ37mm(Viewable) φ23mm
Lamp Size	230x170x100mm
Net Weight	1350g



**Description**

Equipped a single high-power Osram LED chip. According to watt optimized drive solution, under hundreds of testing, realize luminous efficacy above 90%. Heat sink's 80% is made from model 1070 Aluminum, heat dissipation up to 95%. Turn On/Off and Rotating/Stop functions are controllable by switch key or remote. Beam angle is 15°

**Image Size Against Projection Distance**

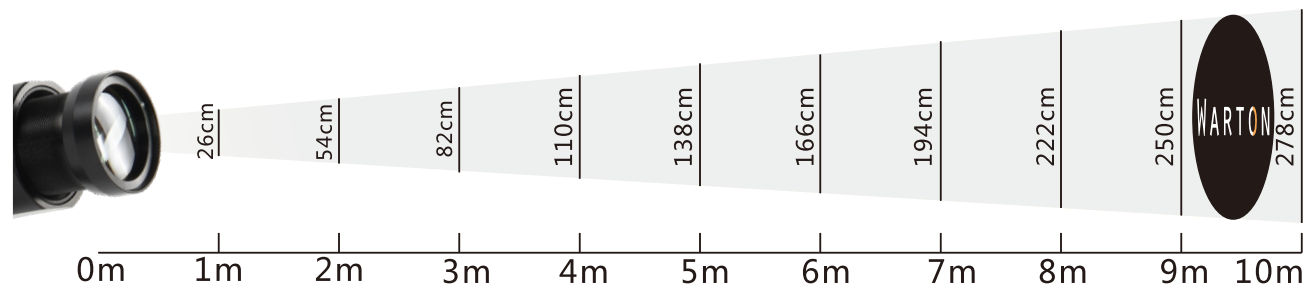

**Small decline**

**IP20 or IP65**

**Long life-span**

**HD image**

**Lamp Details**



**Cases**



## Specification

### 15W Image Static Recessed Type



Model NO.	WT-sr1520
Colors	Black (customizable)
LED chips	1x15W by CREE
Beam Angle	15° or 25°
Input Voltage	AC 85-265V
Projection Distance	10M ( Dark Areas )
Waterproof	IP20
Gobo Spec	(Size) $\phi$ 37mm(Viewable) $\phi$ 23mm
Lamp Size	230x170x100mm
Cut size	900mm
Net Weight	1100g



## Description

15W Recessed type gobo lamp is special designed for hotel, club, room number show and etc. indoor use. Heat sink's 80% is made from model 1070 Aluminum, heat dissipation up to 95% Acceptable 24 hour cont-inuous lighting for 60,000-80,000 hours lifespan. Equipped a single high-power CREE LED chip, super heat-conducting copper board.

## Image Size Against Projection Distance

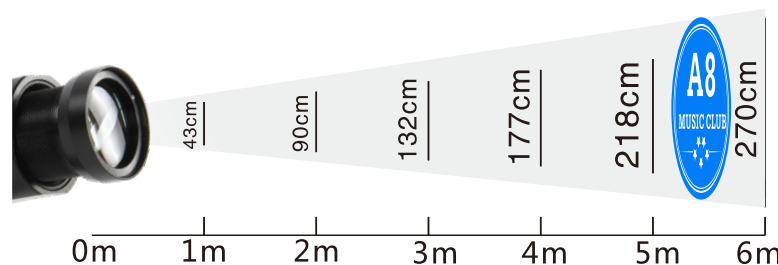
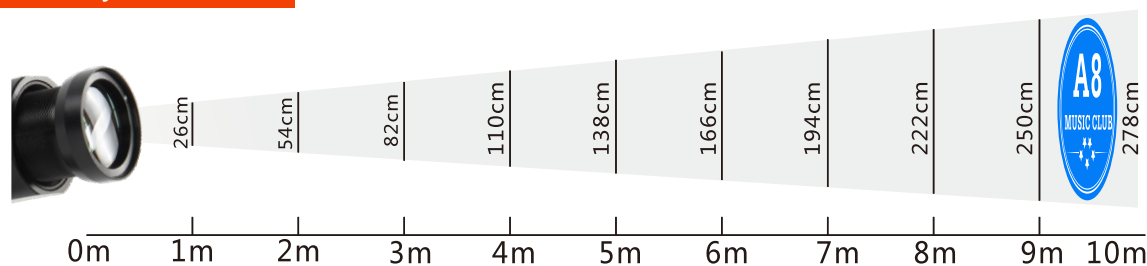

(\*Bigger image type)



### 30W Image Rotatable Track Type

Model NO. :WT-tr3020  
 Colors:Black (customizable)  
 LED chips : 1x30W by Osram  
 Beam Angle:15°  
 Input Voltage : 110V or 220V(±20V)  
 Projection Distance : 10-30M ( Dark Areas )  
 Waterproof : IP20  
 Gobo Spec. : (Size)  $\phi$ 37mm (Viewable)  $\phi$ 23mm



### 15W Image Rotatable Track Type

Model NO. :WT-tr1520  
 Colors:Black (customizable)  
 LED chips : 1x15W by Cree  
 Beam Angle:15°  
 Input Voltage : 85-265V  
 Projection Distance : 10M ( Dark Areas )  
 Waterproof : IP20  
 Gobo Spec. : (Size)  $\phi$ 37mm (Viewable)  $\phi$ 23mm



### 15W Image Static Track Type

Model NO. :WT-ts1520  
 Colors:Black (customizable)  
 LED chips : 1x15W by Cree  
 Beam Angle:15° or 25°  
 Input Voltage : 85-265V  
 Projection Distance : 10M ( Dark Areas )  
 Waterproof : IP20  
 Gobo Spec. : (Size)  $\phi$ 37mm (Viewable)  $\phi$ 23mm

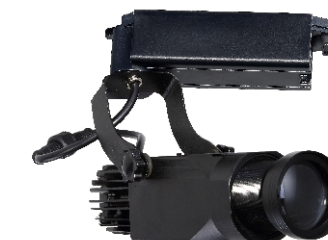

### 30W Image Static Track Type

Model NO. :WT-ts1520  
 Colors:Black (customizable)  
 LED chips : 1x30W by Osram  
 Beam Angle:15°  
 Input Voltage : 85-265V  
 Projection Distance : 10-30M ( Dark Areas )  
 Waterproof : IP20  
 Gobo Spec. : (Size)  $\phi$ 37mm (Viewable)  $\phi$ 23mm

## Specification



## 40W Image Rotatable Type

Model NO.	WT-rt4065
Colors	Black (customizable)
LED chips	1x40W by OSRAM
Beam Angle	10°/13.5°/30°/45°
Input Voltage	AC110V or 220V(±20V)
Projection Distance	MAX 80M ( Dark Areas )
Waterproof	Ip65
Gobo Spec	(Size) φ37mm(Viewable) φ23mm
Lamp Size	230x165x140mm
Net Weight	2380g



## Description

The master of outdoors advertising, high lumen series possesses Low power, Far distance, super HD. Equipped original high-power Osram LED chip, super heat-conducting copper board. Heat sink's 80% is made from model 1070 Aluminum, heat dissipation up to 95%. Independent research and develop drive solution, even electrolysis are used for 30,000 hours, realize luminous efficacy above 90%. Beam angle are 10°/13.5°/30°/45° for your selection.

## Image Size Against Projection Distance

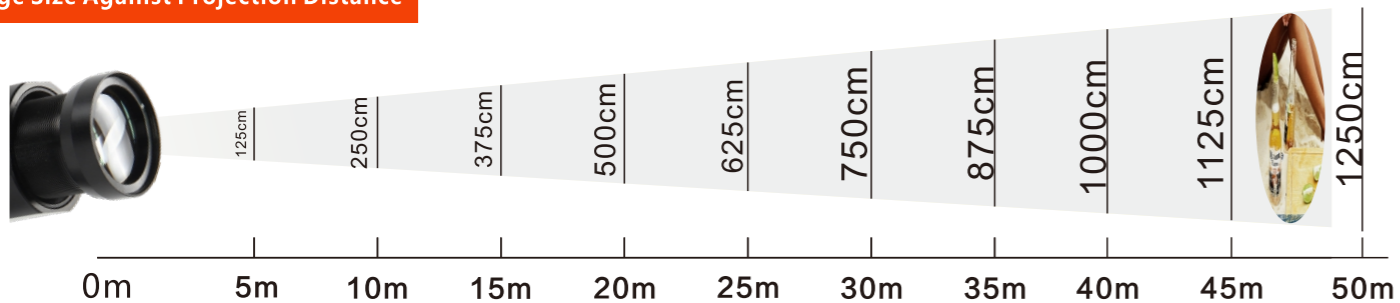

Small decline

IP20 or IP65

Long life-span

HD image

## Lamp Details



## Cases





## Specification



## 60W Image Rotatable Type

Model NO.	WT-rt6065
Colors	Black (customizable)
LED chips	1x60W by OSRAM
Beam Angle	10°/13.5°/30°/45°
Input Voltage	AC 85-265V
Projection Distance	MAX 120M ( Dark Areas )
Waterproof	Ip65
Gobo Spec	(Size) $\phi$ 37mm(Viewable) $\phi$ 23mm
Lamp Size	270x165x140mm
Net Weight	2685g



## Description

The master of outdoors advertising, high lumen series possesses Low power, Far distance, super HD. Equipped original high-power Osram LED chip, super heat-conducting copper board. Heat sink's 80% is made from model 1070 Aluminum, heat dissipation up to 95% Independent research and develop drivesolution, even electrolysis are used for 30,000 hours, realize luminous efficacy above 90%. Beam angle are 10°/13.5°/30°/45° for your selection.

## Image Size Against Projection Distance

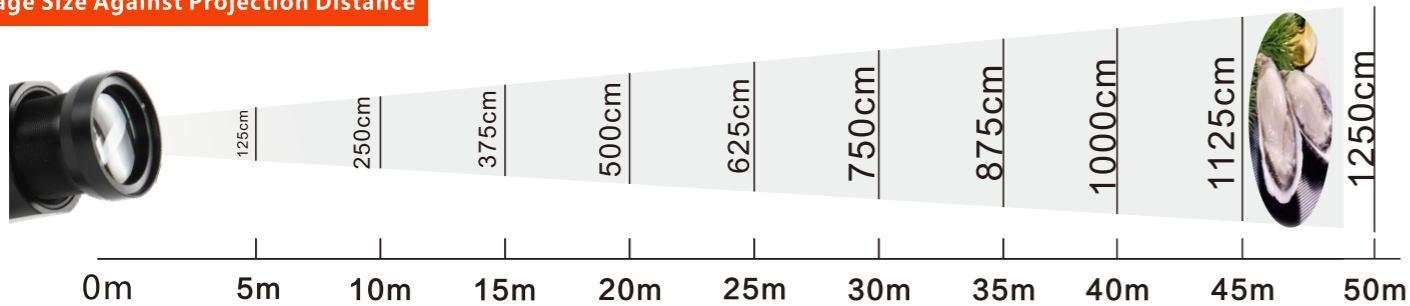

Small decline

IP20 or IP65

Long life-span

HD image

## Lamp Details



## Cases



**Specification**

**80W Image Rotatable Type**



Model NO.	WT-rt8065
Colors	Black (customizable)
LED chips	80W by OSRAM
Beam Angle	10°/13.5°/30°/45°
Input Voltage	AC 85-265V
Projection Distance	MAX 200M ( Dark Areas )
Waterproof	Ip65
Gobo Spec	(Size) φ37mm(Viewable) φ23mm
Lamp Size	270x171x152mm
Net Weight	2715g



**Description**

The master of outdoors advertising, high lumen series possesses Low power, Far distance, super HD. Equipped original high-power Osram LED chip, super heat-conducting copper board. Heat sink's 80% is made from model 1070 Aluminum, heat dissipation up to 95%Indep-endent research and develop drive solution, even electrolysis are used for 30,000 hours, realize luminous efficacy above 90%. Beam angle are 10°/13.5°/30°/45° for your selection.

**Image Size Against Projection Distance**

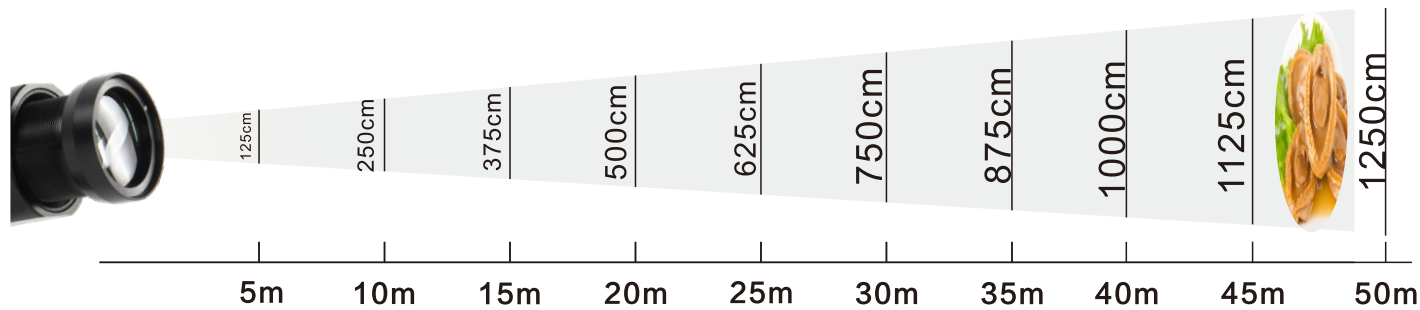

**Lamp Details**



**Cases**



## Specification

### 40/60/80W Image Auto-switch Type



Model NO.	WT-gc4065/WT-gc6065/WT-gc8065
Colors	Black (customizable)
LED chips	1x40W by OSRAM/1x60W by OSRAM/1x80W by OSRAM
Beam Angle	13.5°
Input Voltage	AC 85-265V
Projection Distance	MAX 200M ( Dark Areas )
Waterproof	Ip65
Gobo Spec	(Size) $\phi$ 30mm(Viewable) $\phi$ 20mm
Images	3 Gobos switchable automatically



## Description

Image auto-switch type has gobo auto switch function for 3 gobos. There nine different shifts between 10s ~90s for switch interval time setting, makes users' images more and convenience. It's the master of outdoors advertising, high lumen series possesses Low power, Far distance, super HD. Equipped original high-power Osram LED chip, super heat-conducting copper board. Heat sink's 80% is made from model 1070 Aluminum, heat dissipation up to 95%Independent research and develop drive solution, even electrolysis are used for 30,000 hours, realize luminous efficacy above 90%. Beam angle are 13.5°/30°/45° for your selection.

## Image Size Against Projection Distance

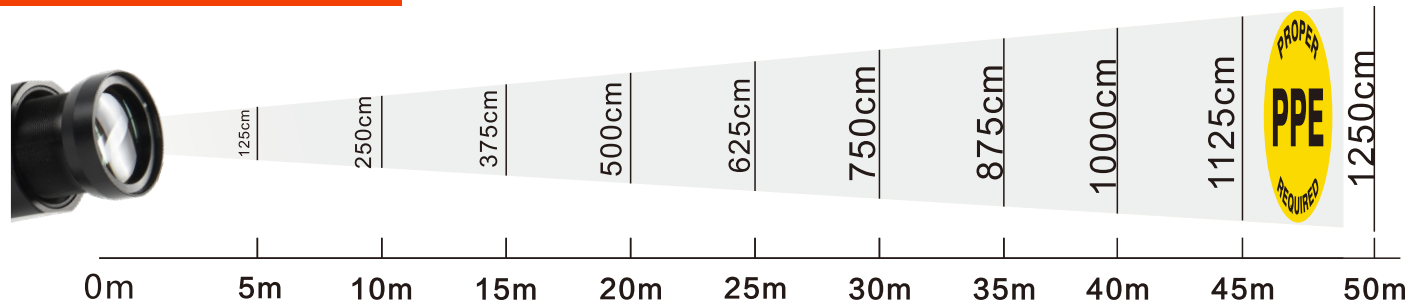

Small decline

IP20 or IP65

Long life-span

HD image

## Lamp Details



Standard Plug

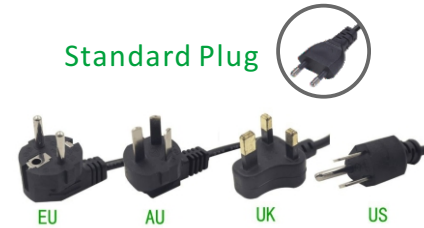

Aluminum Alloy shell



Long Life Osram Led

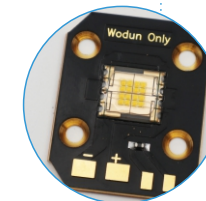

Drive



3 Gobos switchable automatically!



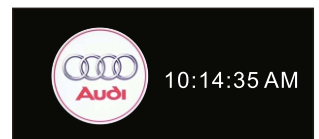
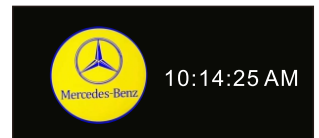
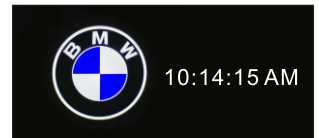

Remote Controller







***3 Gobos switchable automatically***





# Custom GOBO

**COLOUR 1** 

**COLOUR 2**  

**COLOUR 3**  

**COLOUR 4**  

**MULTICOLOUR**     

**Coated glass imported from Germany**

**Never fade**

**Engraving accuracy up to 0.01mm**



- Step 1: Supply the original artwork or HD picture to us.
- Step 2: Our designer edits the raw file to be finished available artwork.
- Step 3: Send to our gobo technology dept. to produce the gobo.

## Warton Gobos Standard Colors:

					
					
					
					
					

*Above are for all models except Image Auto-switch Type.*

					
					

*Above are for Image Auto-switch Type only.*

# We are making:

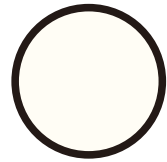

Uniform luminance

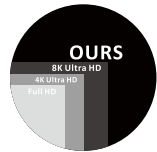

Ultra HD



High Brightness

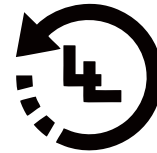

Long Lifespan



User Experience Better

# By

## Optics System

Optical source utilization above 90%



## LED Chips

Custom encapsulation from international first-line brand



## Driver

Excess capacity reserved design



## GOBOs

Germanic material, -40°C~300°C resisted, no color fading



## Optical Lens

99.9% light transmittance, high temperature resistance



## Lamp Body & Heat Sink

Model 1070 AL, patented radiating surface design, oxidation treatment



## Waterproof

Lifetime waterproof structure design



## Ordering

One on one all-round order tracking combine multichannel ordering term.



## Using & Aftersales

Multi-media using, maintenance and warranty tutorials and policy



Warton gobo size standard:

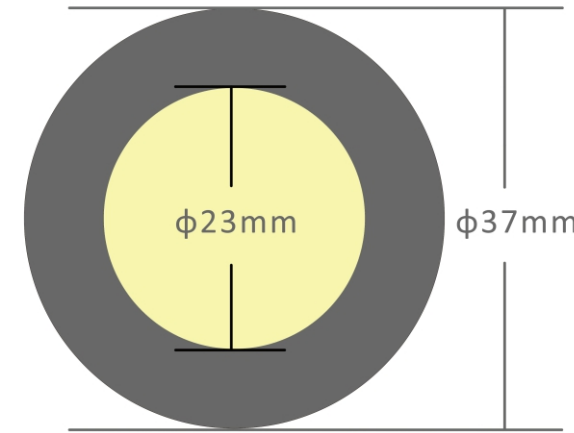

Whole Gobo Size:  $\phi$  37mm

Viewable Size:  $\phi$  23mm

(for all models except Image Auto-switch Type)

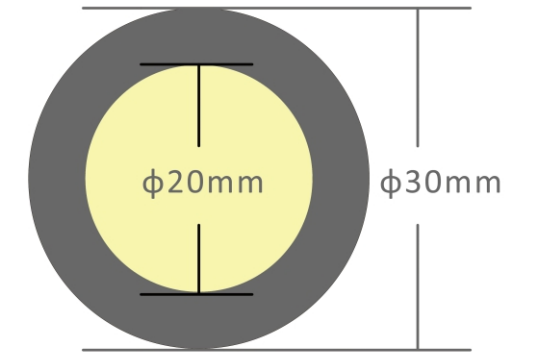

Whole Gobo Size:  $\phi$  30mm

Viewable Size:  $\phi$  20mm

For Image Auto-switch Type only

